

CBP1-80

Made in Taiwan

Electrical Rating	10A 300VAC
Housing Material	Polyamide 66, Green
Contact	Phosphor Bronze, 0.4t, Nickel Plated
Screw	M2.6, Steel, Zinc Plated
Cage clamp	Brass, 0.7t, Nickel Plated
Solder Pin	Brass, Tin Plated
Working Temperature	-40°C to +105°C
Insulation withstand Voltage	AC2000V at 1 min
Insulation resistance	500MΩ or more at DC 500V
Wire Range	24~14 AWG
Max. Torque Value	5kg/cm
Number of Poles	2P~16P
Pitch (terminal to terminal)	5mm

Unit : mm

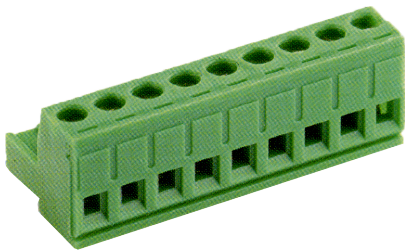

CBP1-80K

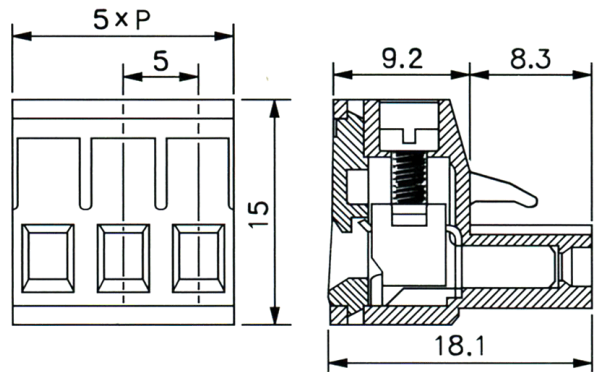

CBP1-80R

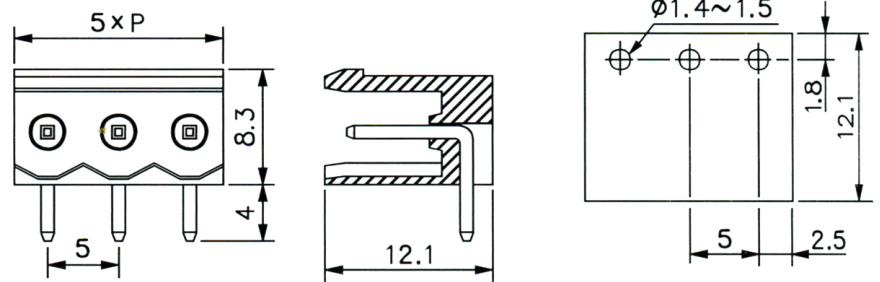

PCB LAYOUT

Unit : mm

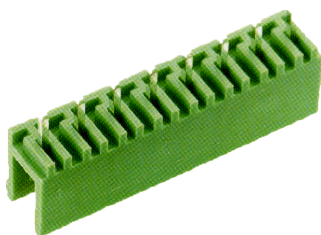

CBP1-80V

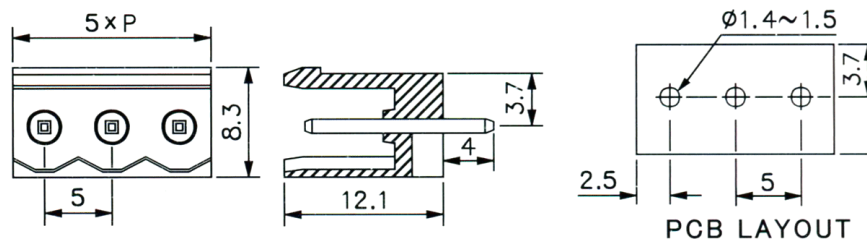

PCB LAYOUT

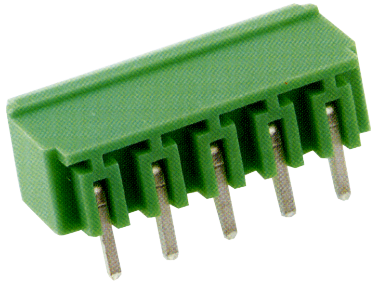

CBP1-80R1

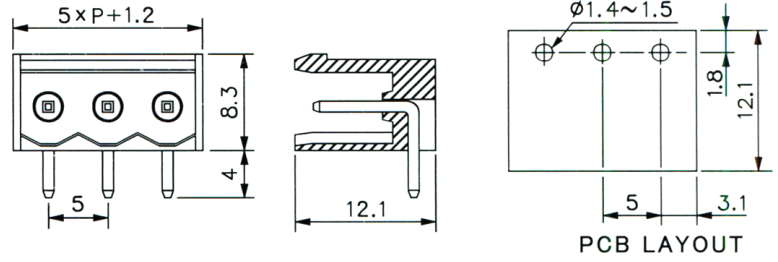

Unit : mm

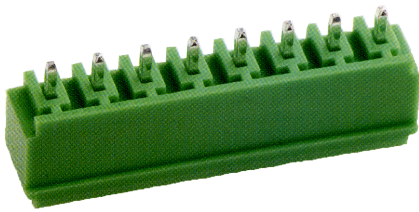

CBP1-80V1

